

## Feed-through header - MSTBV 2,5/ 9-G-5,08 - 1758089

Please be informed that the data shown in this PDF Document is generated from our Online Catalog. Please find the complete data in the user's documentation. Our General Terms of Use for Downloads are valid (<http://phoenixcontact.com/download>)

PCB headers, nominal current: 12 A, number of positions: 9, pitch: 5.08 mm, color: green, contact surface: Tin, mounting: Wave soldering



The figure shows a 10-position version of the product

### Your advantages

- ✓ Maximum flexibility when it comes to device design – one header for connectors with different connection technologies
- ✓ Well-known mounting principle allows worldwide use
- ✓ Vertical connection enables multi-row arrangement on the PCB
- ✓ Items that can be aligned in various pitches support flexible and space-saving PCB assembly
- ✓ Easy PCB replacement thanks to plug-in modules



### Key Commercial Data

Packing unit	1 pc
Minimum order quantity	100 pc
GTIN	 4 017918 030292
GTIN	4017918030292
Weight per Piece (excluding packing)	3.200 g
Custom tariff number	85366930
Country of origin	Germany

### Technical data

#### Dimensions

Length [ l ]	8.57 mm
Width	45.72 mm
Pitch	5.08 mm

## Feed-through header - MSTBV 2,5/ 9-G-5,08 - 1758089

### Technical data

#### Dimensions

Dimension a	40.64 mm
Width [ w ]	45.72 mm
Height [ h ]	15.9 mm
Height	12 mm
Length of the solder pin	3.9 mm
Pin dimensions	1 x 1 mm
Length	8.57 mm

#### General

Range of articles	MSTBV 2,5/..-G
Insulating material group	I
Rated surge voltage (III/3)	4 kV
Rated surge voltage (III/2)	4 kV
Rated surge voltage (II/2)	4 kV
Rated voltage (III/3)	250 V
Rated voltage (III/2)	320 V
Rated voltage (II/2)	400 V
Connection in acc. with standard	EN-VDE
Nominal current I <sub>N</sub>	12 A
Maximum load current	12 A
Insulating material	PA
Flammability rating according to UL 94	V0
Color	green
Number of positions	9

#### Standards and Regulations

Connection in acc. with standard	EN-VDE
	CSA
Flammability rating according to UL 94	V0

#### Environmental Product Compliance

China RoHS	Environmentally friendly use period: unlimited = EFUP-e
	No hazardous substances above threshold values

### Drawings

# Feed-through header - MSTBV 2,5/ 9-G-5,08 - 1758089

Drilling diagram

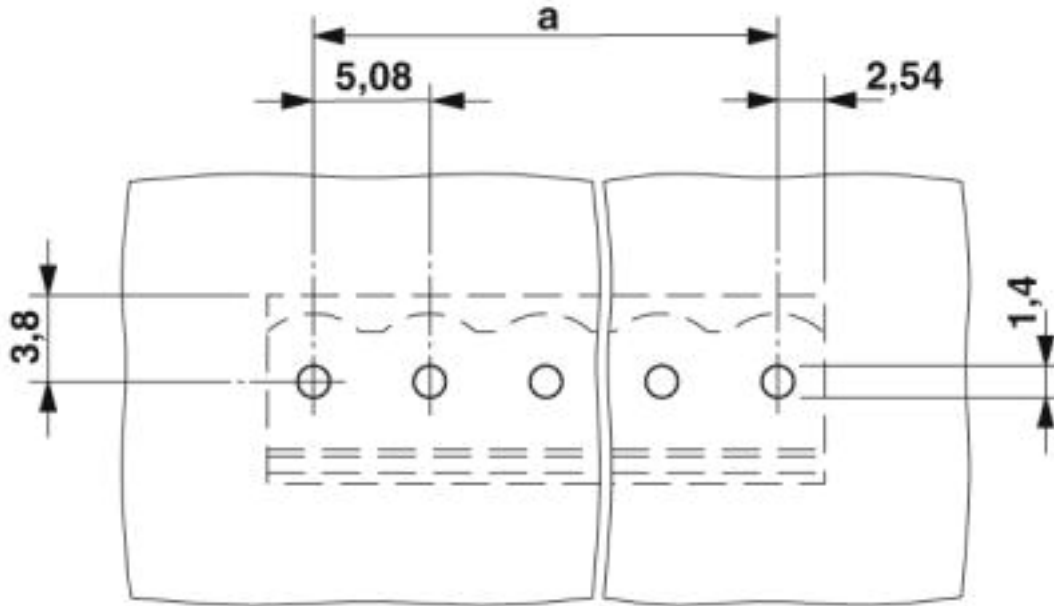

Diagram

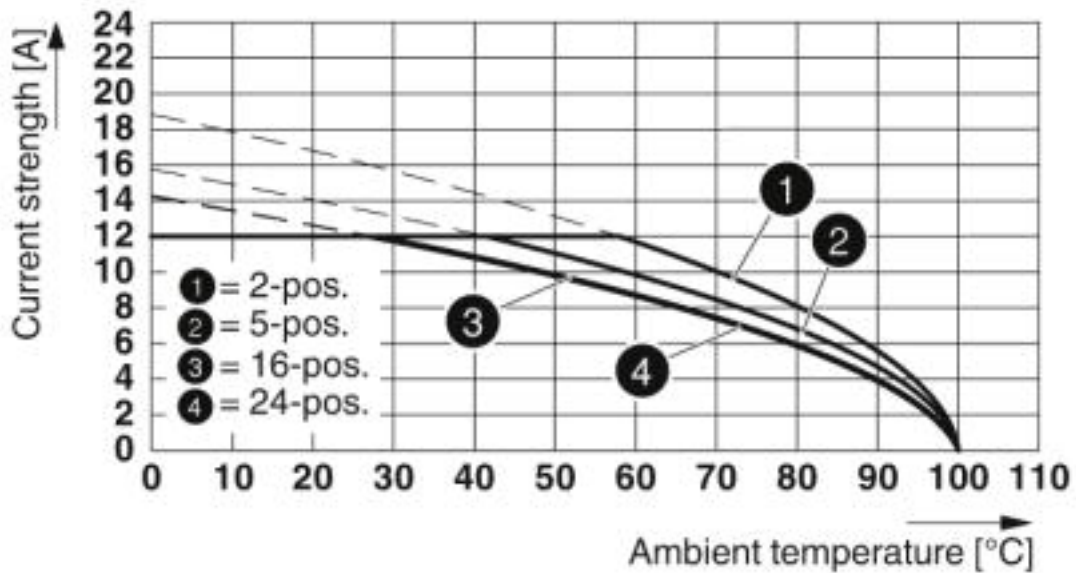

Type: MSTBP 2,5/...-ST-5,08 with MSTBV 2,5/...-G-5,08

# Feed-through header - MSTBV 2,5/ 9-G-5,08 - 1758089

Diagram

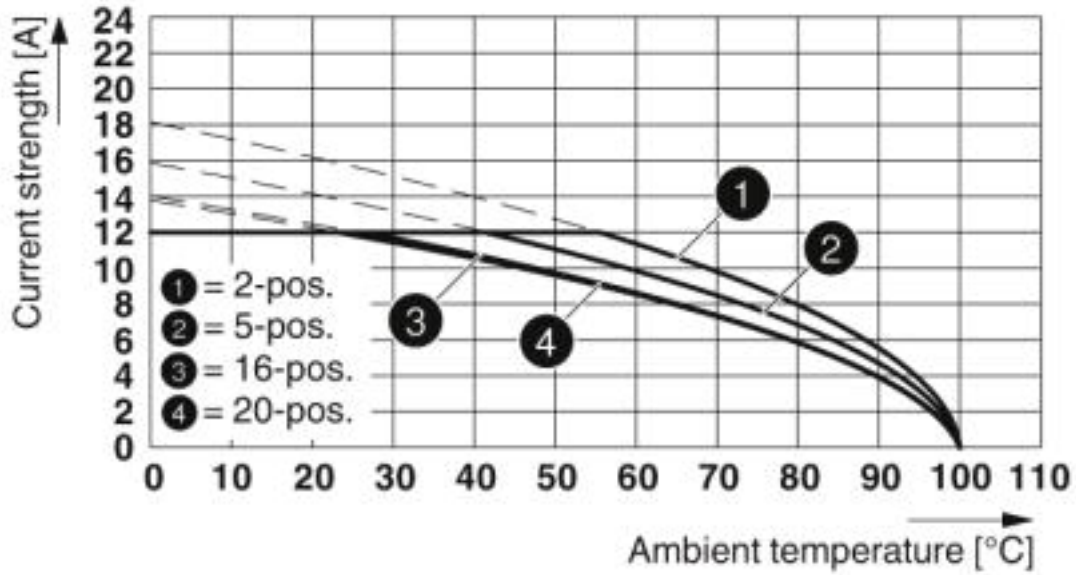

Type: MSTB 2,5/...-ST-5,08 with MSTBV 2,5/...-G-5,08

Diagram

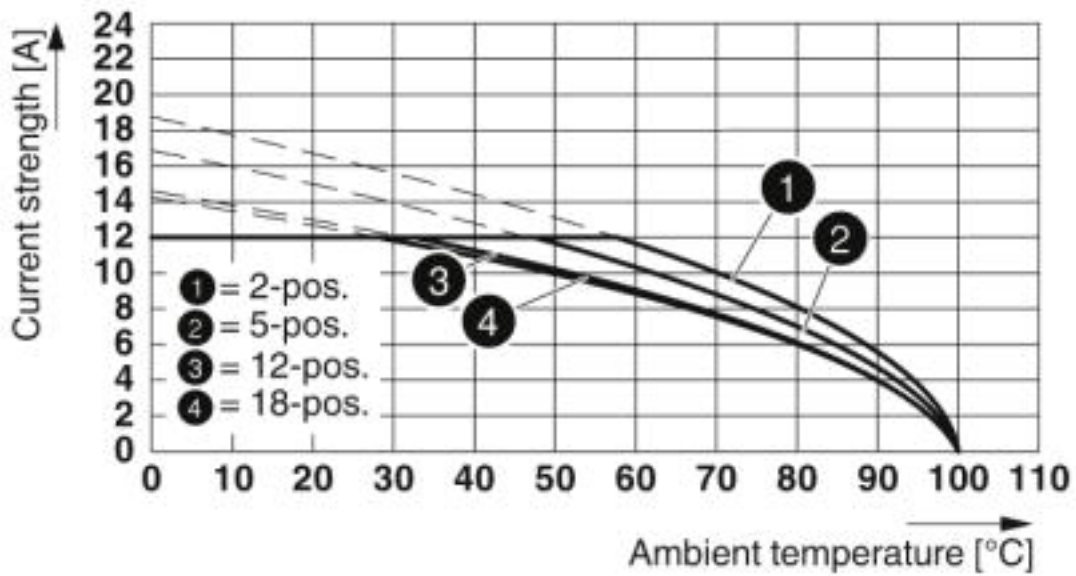

Type: MSTBT 2,5/...-ST-5,08 with MSTBV 2,5/...-G-5,08-5,08

# Feed-through header - MSTBV 2,5/ 9-G-5,08 - 1758089

Diagram

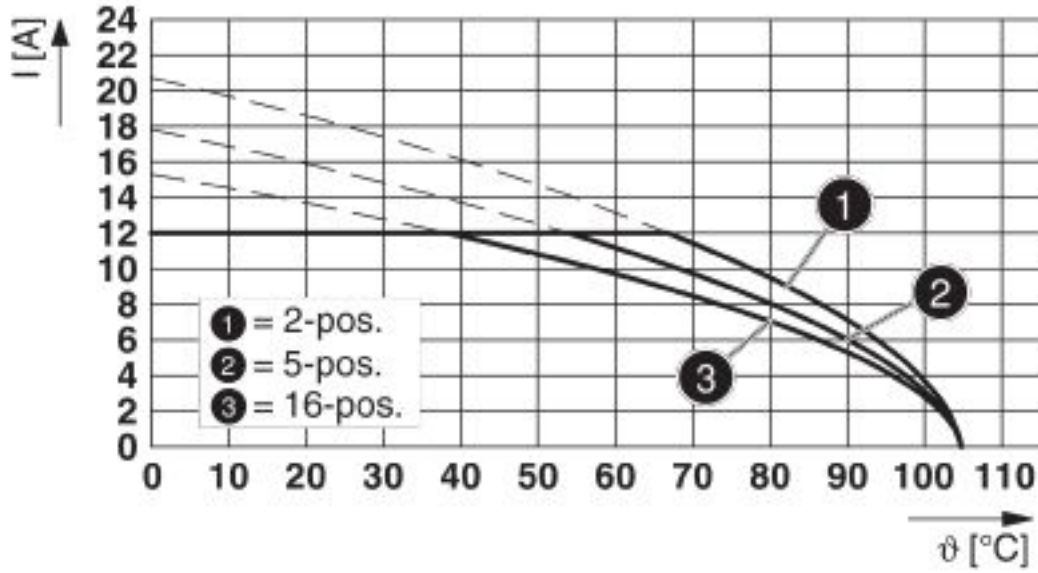

Type: FKCVR 2,5/...-ST-5,08 with MSTBV 2,5/...-G-5,08

Diagram

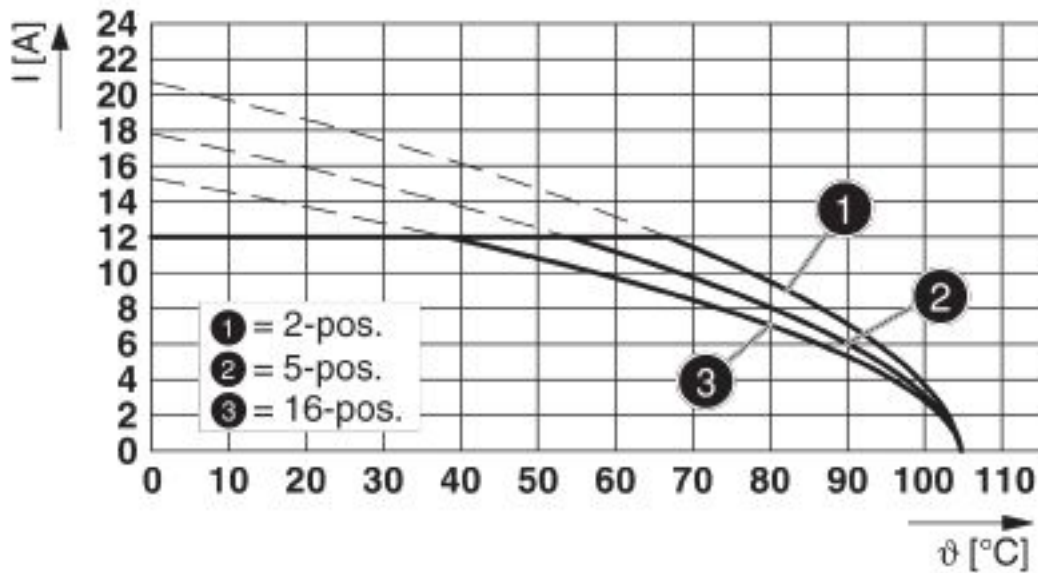

Type: FKCVW 2,5/...-ST-5,08 with MSTBV 2,5/...-G-5,08

## Feed-through header - MSTBV 2,5/ 9-G-5,08 - 1758089

Dimensional drawing

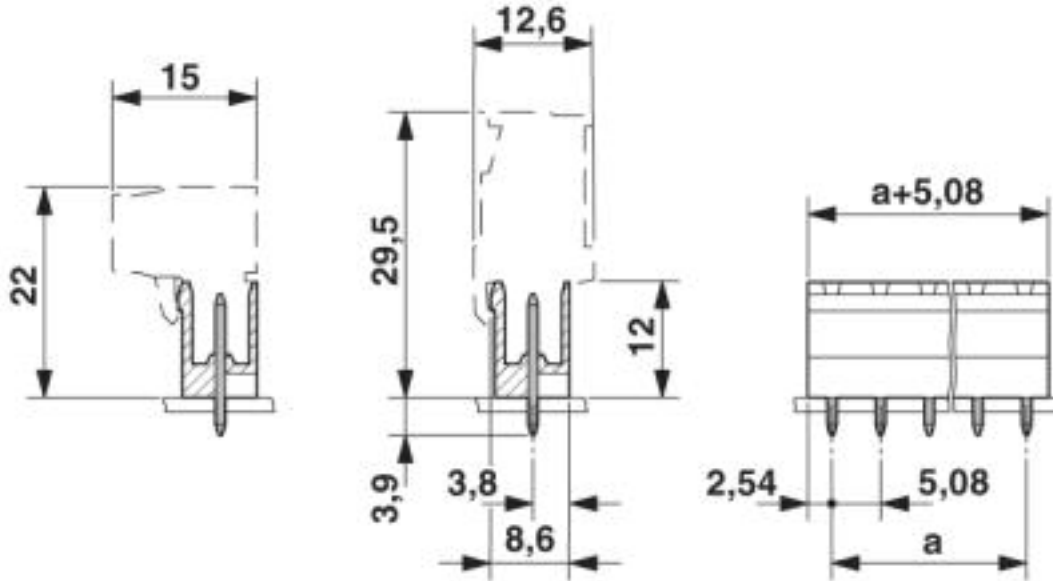

### Classifications

eCl@ss

eCl@ss 4.0	27260700
eCl@ss 4.1	27260700
eCl@ss 5.0	27260700
eCl@ss 5.1	27260700
eCl@ss 6.0	27260700
eCl@ss 7.0	27440402
eCl@ss 8.0	27440402
eCl@ss 9.0	27440402

ETIM

ETIM 3.0	EC001121
ETIM 4.0	EC002637
ETIM 5.0	EC002637
ETIM 6.0	EC002637
ETIM 7.0	EC002637

UNSPSC

UNSPSC 6.01	30211810
UNSPSC 7.0901	39121409
UNSPSC 11	39121409

# Feed-through header - MSTBV 2,5/ 9-G-5,08 - 1758089

## Classifications

### UNSPSC

UNSPSC 12.01	39121409
UNSPSC 13.2	39121409

## Approvals

### Approvals

#### Approvals

CSA / IECEE CB Scheme / VDE Gutachten mit Fertigungsüberwachung / EAC / cULus Recognized

#### Ex Approvals

### Approval details

CSA		<a href="http://www.csagroup.org/services-industries/product-listing/">http://www.csagroup.org/services-industries/product-listing/</a>	13631
	B	D	
Nominal voltage UN	300 V	300 V	
Nominal current IN	12 A	10 A	

IECEE CB Scheme		<a href="http://www.iecee.org/">http://www.iecee.org/</a>	DE1-60988-B1B2
Nominal voltage UN	250 V		
Nominal current IN	12 A		

VDE Gutachten mit Fertigungsüberwachung		<a href="http://www2.vde.com/de/Institut/Online-Service/VDE-gepruefteProdukte/Seiten/Online-Suche.aspx">http://www2.vde.com/de/Institut/Online-Service/VDE-gepruefteProdukte/Seiten/Online-Suche.aspx</a>	40004701
Nominal voltage UN	250 V		
Nominal current IN	12 A		

# Feed-through header - MSTBV 2,5/ 9-G-5,08 - 1758089

## Approvals

EAC		B.01742
-----	--	---------

cULus Recognized		<a href="http://database.ul.com/cgi-bin/XYV/template/LISEXT/1FRAME/index.htm">http://database.ul.com/cgi-bin/XYV/template/LISEXT/1FRAME/index.htm</a>	E60425-19931011
	B	D	
Nominal voltage UN	300 V	300 V	
Nominal current IN	12 A	10 A	

## Accessories

### Accessories

#### Coding element

Coding section - CR-MSTB - 1734401



Coding section, inserted into the recess in the header or the inverted plug, red insulating material

#### Filler plug

Accessories - MSTB-BL - 1755477



Keying cap, for forming sections, plugs onto header pin, green insulating material

#### Labeled terminal marker

Marker card - SK 5,08/3,8:FORTL.ZAHLEN - 0804293



Marker card, Card, white, labeled, Horizontal: consecutive numbers 1 ... 10, 11 ... 20, etc. up to 91 ... (99)100, mounting type: adhesive, for terminal block width: 5.08 mm, lettering field size: 5.08 x 3.8 mm

## Feed-through header - MSTBV 2,5/ 9-G-5,08 - 1758089

### Accessories

---

#### Marker pen

Marker pen - B-STIFT - 1051993



Marker pen, for manual labeling of unprinted Zack strips, smear-proof and waterproof, line thickness 0.5 mm

---

#### Terminal marking

Marker card - SK 5,08/3,8:UNBEDRUCKT - 0805412



Marker card, Card, white, unlabeled, can be labeled with: Marker pen, mounting type: adhesive, for terminal block width: 5.08 mm, lettering field size: 5.08 x 3.8 mm

---

#### Additional products

Printed-circuit board connector - TVMSTB 2,5/ 9-ST-5,08 - 1719079



PCB connector, nominal current: 12 A, number of positions: 9, pitch: 5.08 mm, connection method: Screw connection with tension sleeve, color: green, contact surface: Tin

---

Printed-circuit board connector - MSTBT 2,5/ 9-ST-5,08 - 1734207



PCB connector, nominal current: 12 A, number of positions: 9, pitch: 5.08 mm, connection method: Screw connection with tension sleeve, color: green, contact surface: Tin

---

## Feed-through header - MSTBV 2,5/ 9-G-5,08 - 1758089

### Accessories

Printed-circuit board connector - FKCN 2,5/ 9-ST-5,08 - 1754636

PCB connector, nominal current: 12 A, number of positions: 9, pitch: 5.08 mm, connection method: Push-in spring connection, color: green, contact surface: Tin



Printed-circuit board connector - MSTB 2,5/ 9-ST-5,08 - 1757080

PCB connector, nominal current: 12 A, number of positions: 9, pitch: 5.08 mm, connection method: Screw connection with tension sleeve, color: green, contact surface: Tin



Printed-circuit board connector - MSTB 2,5/ 9-STZ-5,08 - 1764316

PCB connector, nominal current: 12 A, number of positions: 9, pitch: 5.08 mm, connection method: Screw connection with tension sleeve, color: green, contact surface: Tin



Printed-circuit board connector - MSTBP 2,5/ 9-ST-5,08 - 1769081

PCB connector, nominal current: 12 A, number of positions: 9, pitch: 5.08 mm, connection method: Screw connection with tension sleeve, color: green, contact surface: Tin



Printed-circuit board connector - FRONT-MSTB 2,5/ 9-ST-5,08 - 1777358

PCB connector, nominal current: 12 A, number of positions: 9, pitch: 5.08 mm, connection method: Front screw connection, color: green, contact surface: Tin



## Feed-through header - MSTBV 2,5/ 9-G-5,08 - 1758089

### Accessories

#### Printed-circuit board connector - MVSTBR 2,5/ 9-ST-5,08 - 1792317



PCB connector, nominal current: 12 A, number of positions: 9, pitch: 5.08 mm, connection method: Screw connection with tension sleeve, color: green, contact surface: Tin

#### Printed-circuit board connector - MVSTBW 2,5/ 9-ST-5,08 - 1792825



PCB connector, nominal current: 12 A, number of positions: 9, pitch: 5.08 mm, connection method: Screw connection with tension sleeve, color: green, contact surface: Tin

#### Printed-circuit board connector - MSTBC 2,5/ 9-ST-5,08 - 1808887



PCB connector, nominal current: 12 A, number of positions: 9, pitch: 5.08 mm, connection method: Crimp connection, color: green, Corresponding female crimp contacts with current [A] and conductor cross section range [mm<sup>2</sup>] data: 10A/MSTBC-MT 0,5-1,0 (3190564); 10A/MSTBC-MT 0,5-1,0 BA (3190645); 12A/MSTBC-MT 1,5-2,5 (3190551); 12A/MSTBC-MT 1,5-2,5 BA (3190658). BA = Bandkontakte

#### Printed-circuit board connector - MSTBC 2,5/ 9-STZ-5,08 - 1809572



PCB connector, nominal current: 12 A, number of positions: 9, pitch: 5.08 mm, connection method: Crimp connection, color: green, Corresponding female crimp contacts with current [A] and conductor cross section range [mm<sup>2</sup>] data: 10A/MSTBC-MT 0,5-1,0 (3190564); 10A/MSTBC-MT 0,5-1,0 BA (3190645); 12A/MSTBC-MT 1,5-2,5 (3190551); 12A/MSTBC-MT 1,5-2,5 BA (3190658). BA = Bandkontakte

#### Printed-circuit board connector - MSTBU 2,5/ 9-STD-5,08 - 1824191



Direct plug-in block, nominal current: 12 A, number of positions: 9, pitch: 5.08 mm, connection method: Screw connection with tension sleeve, color: green, contact surface: Tin, mounting: Direct mounting

## Feed-through header - MSTBV 2,5/ 9-G-5,08 - 1758089

### Accessories

Printed-circuit board connector - MSTBU 2,5/ 9-ST-5,08-FL - 1824421



Direct plug-in block, nominal current: 12 A, number of positions: 9, pitch: 5.08 mm, connection method: Screw connection with tension sleeve, color: green, contact surface: Tin, mounting: Direct mounting

Printed-circuit board connector - SMSTB 2,5/ 9-ST-5,08 - 1826351



PCB connector, nominal current: 12 A, number of positions: 9, pitch: 5.08 mm, connection method: Screw connection with tension sleeve, color: green, contact surface: Tin

Printed-circuit board connector - MSTBVK 2,5/ 9-ST-5,08 - 1831388



DIN rail connector, nominal current: 12 A, number of positions: 9, pitch: 5.08 mm, connection method: Screw connection with tension sleeve, color: green, contact surface: Tin, mounting: DIN rail

Printed-circuit board connector - UMSTBVK 2,5/ 9-ST-5,08 - 1833881



DIN rail connector, nominal current: 12 A, number of positions: 9, pitch: 5.08 mm, connection method: Screw connection with tension sleeve, color: green, contact surface: Tin, mounting: DIN rail

Printed-circuit board connector - TMSTBP 2,5/ 9-ST-5,08 - 1853081



PCB connector, nominal current: 12 A, number of positions: 9, pitch: 5.08 mm, connection method: Screw connection with tension sleeve, color: green, contact surface: Tin, The plug allows conductors to be looped through from module to module.

## Feed-through header - MSTBV 2,5/ 9-G-5,08 - 1758089

### Accessories

Printed-circuit board connector - FKC 2,5/ 9-ST-5,08 - 1873126



PCB connector, nominal current: 12 A, number of positions: 9, pitch: 5.08 mm, connection method: Push-in spring connection, color: green, contact surface: Tin

Printed-circuit board connector - FKCVW 2,5/ 9-ST-5,08 - 1873728



PCB connector, nominal current: 12 A, number of positions: 9, pitch: 5.08 mm, connection method: Push-in spring connection, color: green, contact surface: Tin

Printed-circuit board connector - FKCVR 2,5/ 9-ST-5,08 - 1874028



PCB connector, nominal current: 12 A, number of positions: 9, pitch: 5.08 mm, connection method: Push-in spring connection, color: green, contact surface: Tin

Printed-circuit board connector - QC 1/ 9-ST-5,08 - 1883323



PCB connector, nominal current: 10 A, number of positions: 9, pitch: 5.08 mm, connection method: Displacement connection, color: green, contact surface: Tin

Printed-circuit board connector - FKCT 2,5/ 9-ST-5,08 - 1902181



PCB connector, nominal current: 12 A, number of positions: 9, pitch: 5.08 mm, connection method: Push-in spring connection, color: green, contact surface: Tin

## Feed-through header - MSTBV 2,5/ 9-G-5,08 - 1758089

### Accessories

Printed-circuit board connector - TFKC 2,5/ 9-ST-5,08 - 1962671

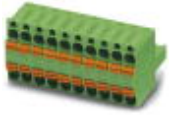

PCB connector, nominal current: 12 A, number of positions: 9, pitch: 5.08 mm, connection method: Push-in spring connection, color: green, contact surface: Tin

---

Printed-circuit board connector - FKCS 2,5/ 9-ST-5,08 - 1975147



PCB connector, nominal current: 12 A, number of positions: 9, pitch: 5.08 mm, connection method: Push-in spring connection, color: green, contact surface: Tin